

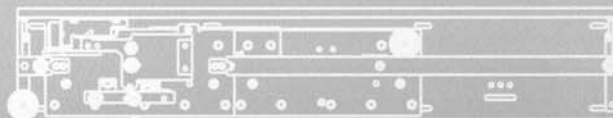

GEMAN AUTOMATIC DOORS

**ΑΥΤΟΜΑΤΕΣ ΠΟΡΤΕΣ
ΑΝΕΛΚΥΣΤΗΡΩΝ**

**AUTOMATIC DOORS
FOR ELEVATORS**



**6-ΦΥΛΛΗ
ΚΕΝΤΡΙΚΗ
6-PANEL
CENTRE**

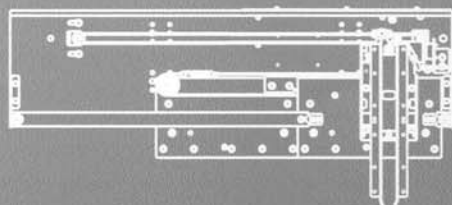
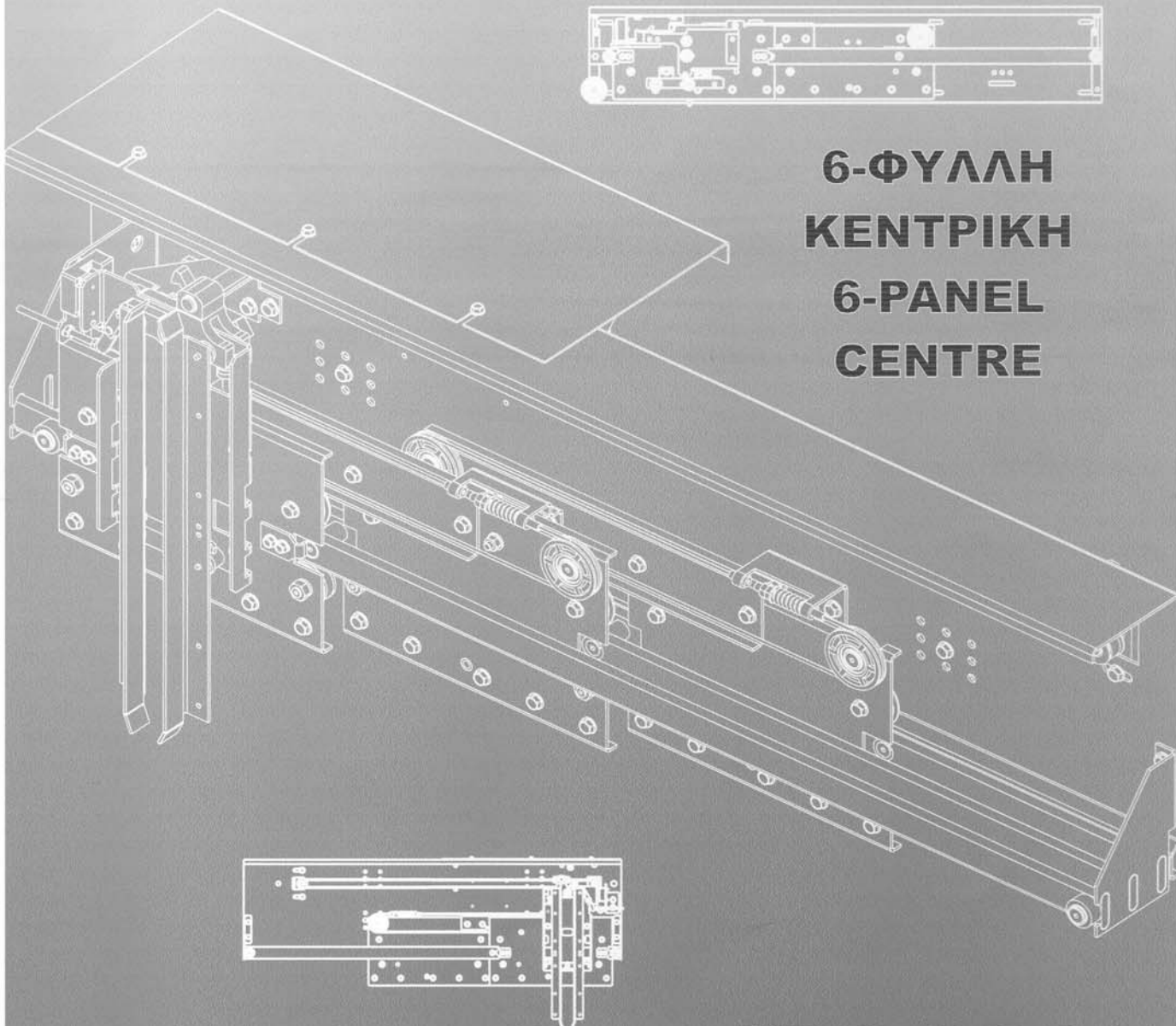

ΕΚΔΟΣΗ
ISSUE 1.25.03

ISO 9001



ΑΥΤΟΜΑΤΗ ΠΟΡΤΑ 6-ΦΥΛΛΗ

ΘΑΛΑΜΟΥ

AUTOMATIC DOOR 6-PANEL

CABIN

ΗΜΕΡΟΜΗΝΙΑ DATE

29/4/2003

ΣΕΛΙΔΑ PAGE

1.1

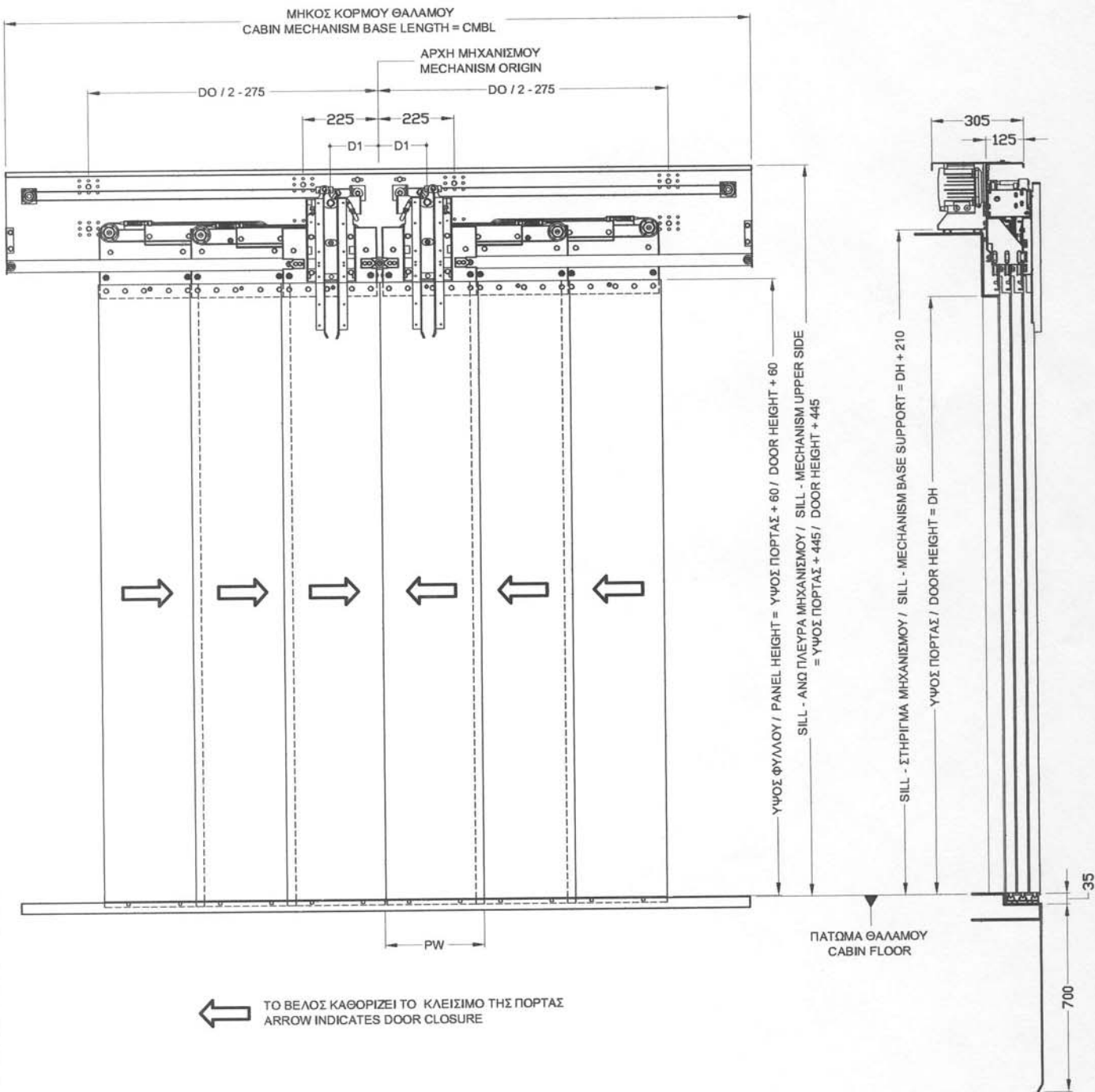

| | | |
|-----------|--------------------|--------------------|
| DO | 1300 - 1600 | 1650 - 3000 |
| D1 | 120 | 160 |



ΑΥΤΟΜΑΤΗ ΠΟΡΤΑ 6-ΦΥΛΛΗ

ΟΡΟΦΟΥ

AUTOMATIC DOOR 6-PANEL

LANDING

ΗΜΕΡΟΜΗΝΙΑ DATE

29/4/2003

ΣΕΛΙΔΑ PAGE

1.2

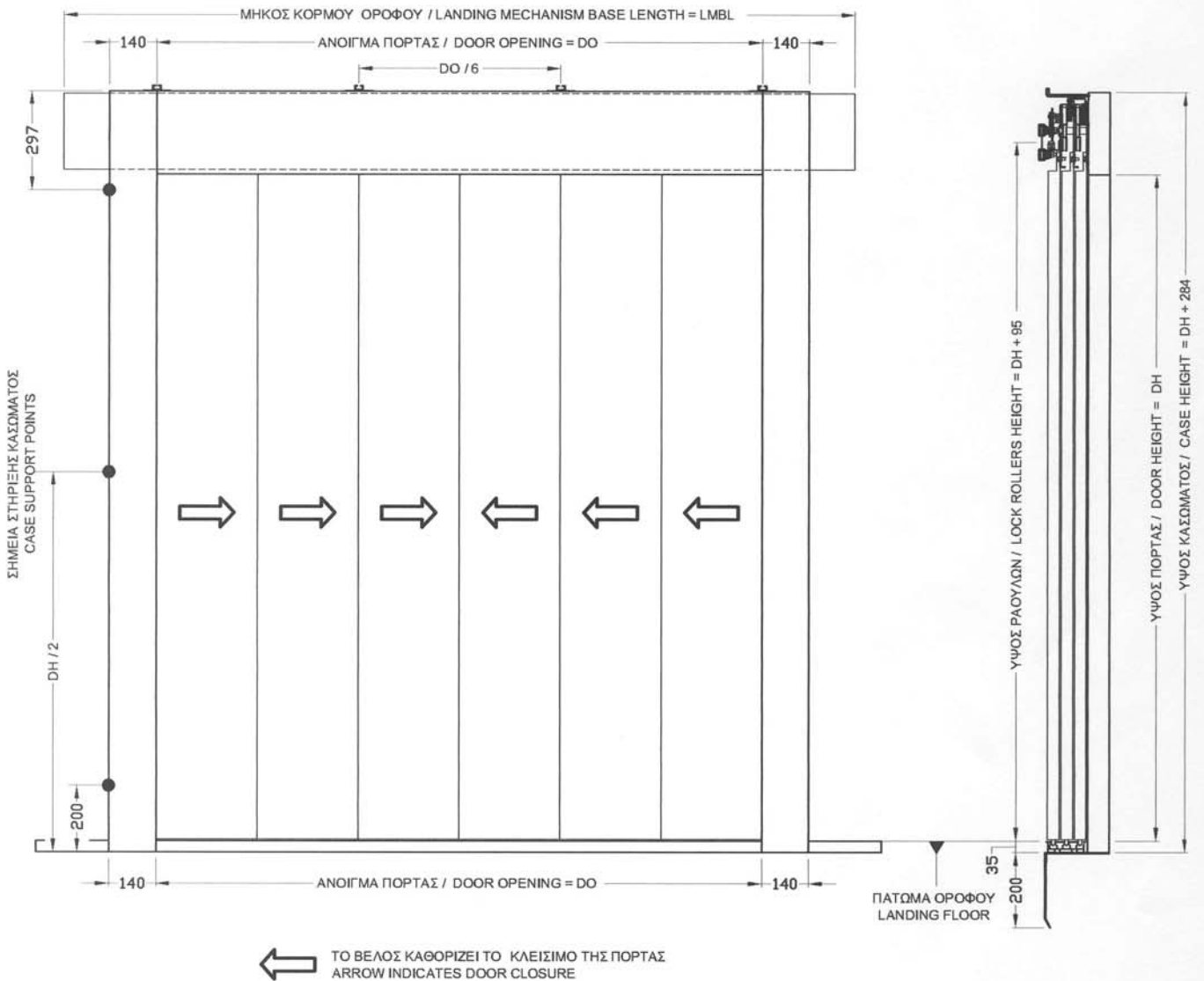

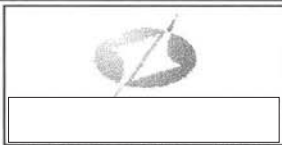

ΑΥΤΟΜΑΤΗ ΠΟΡΤΑ 6-ΦΥΛΛΗ

ΟΡΟΦΟΥ - ΘΑΛΑΜΟΥ

AUTOMATIC DOOR 6-PANEL

LANDING - CABIN

ΗΜΕΡΟΜΗΝΙΑ DATE

29/4/2003

ΣΕΛΙΔΑ PAGE

1.3

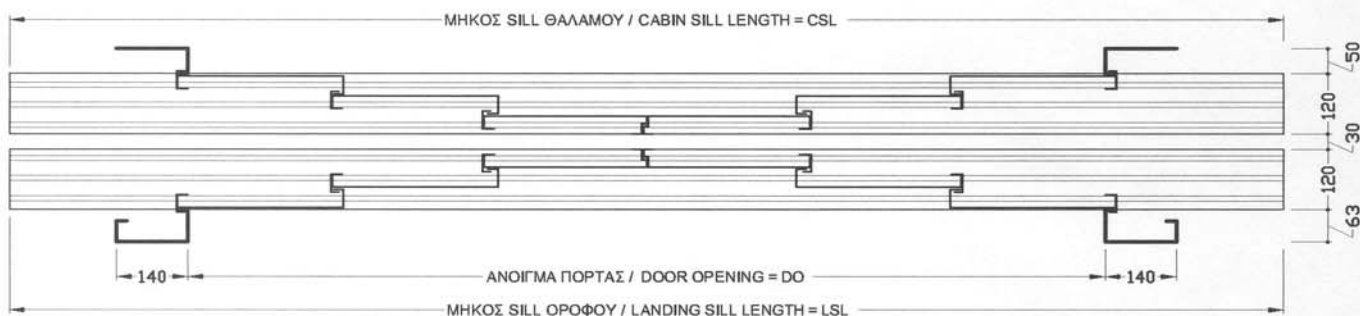

| DO | | 1300 | 1350 | 1400 | 1450 | 1500 | 1550 | 1600 | 1650 | 1700 | 1750 | 1800 |
|------|--|------|------|------|------|------|------|------|------|------|------|------|
| PW | | 246 | 255 | 263 | 271 | 280 | 288 | 296 | 305 | 313 | 321 | 330 |
| CMBL | | 1793 | 1860 | 1926 | 1993 | 2060 | 2126 | 2193 | 2260 | 2326 | 2393 | 2460 |
| LMBL | | | | | | | | | | | | 2460 |
| CSL | | 1790 | 1860 | 1920 | 1993 | 2060 | 2120 | 2190 | 2260 | 2320 | 2390 | 2460 |
| LSL | | 1790 | 1860 | 1920 | 1993 | 2060 | 2120 | 2190 | 2260 | 2320 | 2390 | 2460 |

| DO | 1850 | 1900 | 1950 | 2000 | 2050 | 2100 | 2150 | 2200 | 2250 | 2300 | 2350 | 2400 |
|------|------|------|------|------|------|------|------|------|------|------|------|------|
| PW | 338 | 346 | 355 | 363 | 371 | 380 | 388 | 396 | 405 | 413 | 421 | 430 |
| CMBL | 2527 | 2593 | 2660 | 2727 | 2793 | 2860 | 2927 | 2993 | 3060 | 3127 | 3193 | 3260 |
| LMBL | 2527 | 2593 | 2660 | 2727 | 2793 | 2860 | 2927 | 2993 | 3060 | 3127 | 3193 | 3260 |
| CSL | 2520 | 2590 | 2660 | 2720 | 2790 | 2860 | 2920 | 2990 | 3060 | 3120 | 3190 | 3260 |
| LSL | 2520 | 2590 | 2660 | 2720 | 2790 | 2860 | 2920 | 2990 | 3060 | 3120 | 3190 | 3260 |

| DO | 2450 | 2500 | 2550 | 2600 | 2650 | 2700 | 2750 | 2800 | 2850 | 2900 | 2950 | 3000 |
|------|------|------|------|------|------|------|------|------|------|------|------|------|
| PW | 438 | 446 | 455 | 463 | 471 | 480 | 488 | 496 | 505 | 513 | 521 | 510 |
| CMBL | 3327 | 3393 | 3460 | 3527 | 3593 | 3660 | 3727 | 3793 | 3860 | 3927 | 3993 | 4060 |
| LMBL | 3327 | 3393 | 3460 | 3527 | 3593 | 3660 | 3727 | 3793 | 3860 | 3927 | 3993 | 4060 |
| CSL | 3320 | 3390 | 3460 | 3520 | 3590 | 3660 | 3720 | 3790 | 3860 | 3920 | 3990 | 4060 |
| LSL | 3320 | 3390 | 3460 | 3520 | 3590 | 3660 | 3720 | 3790 | 3860 | 3920 | 3990 | 4060 |



ΑΥΤΟΜΑΤΗ ΠΟΡΤΑ 6-ΦΥΛΛΗ

ΟΡΟΦΟΥ

AUTOMATIC DOOR 6-PANEL

LANDING

ΗΜΕΡΟΜΗΝΙΑ DATE

29/4/2003

ΣΕΛΙΔΑ PAGE

1.4

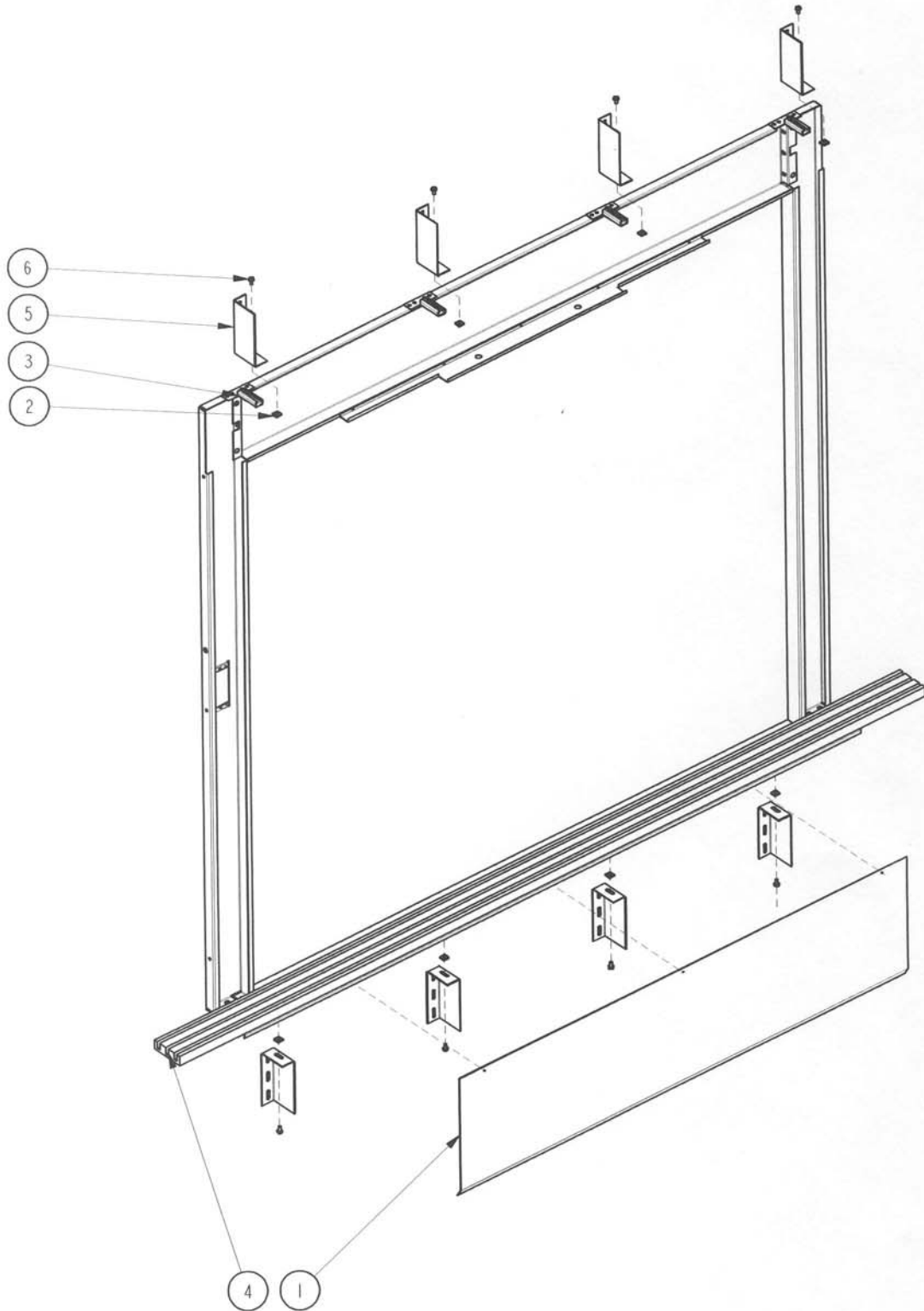



ΑΥΤΟΜΑΤΗ ΠΟΡΤΑ 6-ΦΥΛΛΗ

ΗΜΕΡΟΜΗΝΙΑ DATE

ΟΡΟΦΟΥ

29/4/2003

AUTOMATIC DOOR 6-PANEL

ΣΕΛΙΔΑ PAGE

LANDING

1.5

| A/A POS. | ΚΩΔΙΚΟΣ CODE | ΠΕΡΙΓΡΑΦΗ DESCRIPTION | ΤΕΜ. PCS. | ΠΑΡΑΤΗΡΗΣΕΙΣ NOTES |
|-------------|-----------------|---|--------------|-----------------------|
| 1 | MI-00A000-AE000 | ΠΟΔΙΑ_6Φ_1800 CASE COVER | 1 | (**) |
| 2 | MI-00A000-AE147 | ΠΑΞΙΜΑΔΙ ΤΕΤΡΑΓΩΝΟ 20*20 M8 SQUARE NUT 20*20 M8 | 8 | |
| 3 | MI-00A000-AE199 | ΚΑΝΑΛΙ Κ85 UPPER CASE SUPPORT K85 | 4 | |
| 4 | MI-09A000-AE018 | ΣΙΛΛΑ 6-ΦΥΛΛΟ ΟΡΟΦΟΥ 6-PANEL LANDING SILL | 1 | (*) / (**) |
| 5 | MI-00A000-AE192 | ΣΤΗΡΙΓΜΑ ΚΑΣΩΜΑΤΟΣ CASE SUPPORT | 8 | |
| 6 | | ΕΞΑΓΩΝΟΣ ΚΟΧΛΙΑΣ ΜΕ ΓΚΡΟΒΕΡ Μ8*16 BOLT WITH LOCK WASHER M8*16- DIN 478 | 8 | |
| | | | | |
| | | | | |
| | | | | |
| | | | | |
| | | | | |
| | | | | |
| | | | | |
| | | | | |
| | | | | |
| | | | | |
| | | | | |
| | | | | |
| | | | | |
| | | | | |
| | | | | |
| | | | | |
| | | | | |

(*) ΓΙΑ ΤΗΝ ΠΑΡΑΓΓΕΛΙΑ ΑΠΑΙΤΕΙΤΑΙ Ο ΤΥΠΟΣ ΚΛΕΙΣΙΜΑΤΟΣ ΤΗΣ ΠΟΡΤΑΣ (ΑΡΙΣΤΕΡΟ-ΔΕΞΙΟ)
FOR ORDERING IS REQUIRED DOOR CLOSING TYPE (LEFT-RIGHT)

(* *) ΓΙΑ ΤΗΝ ΠΑΡΑΓΓΕΛΙΑ ΑΠΑΙΤΕΙΤΑΙ ΤΟ ΑΝΟΙΓΜΑ ΤΗΣ ΠΟΡΤΑΣ
FOR ORDERING IS REQUIRED DOOR WIDTH

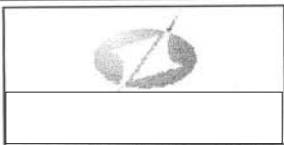

ΑΥΤΟΜΑΤΗ ΠΟΡΤΑ 6-ΦΥΛΛΗ

ΟΡΟΦΟΥ - ΘΑΛΑΜΟΥ

AUTOMATIC DOOR 6-PANEL

LANDING - CABIN

ΗΜΕΡΟΜΗΝΙΑ DATE

29/4/2003

ΣΕΛΙΔΑ PAGE

1.9

